



AUTOHOME®

# AUTOHOME X LAND ROVER INSTRUCTIONS





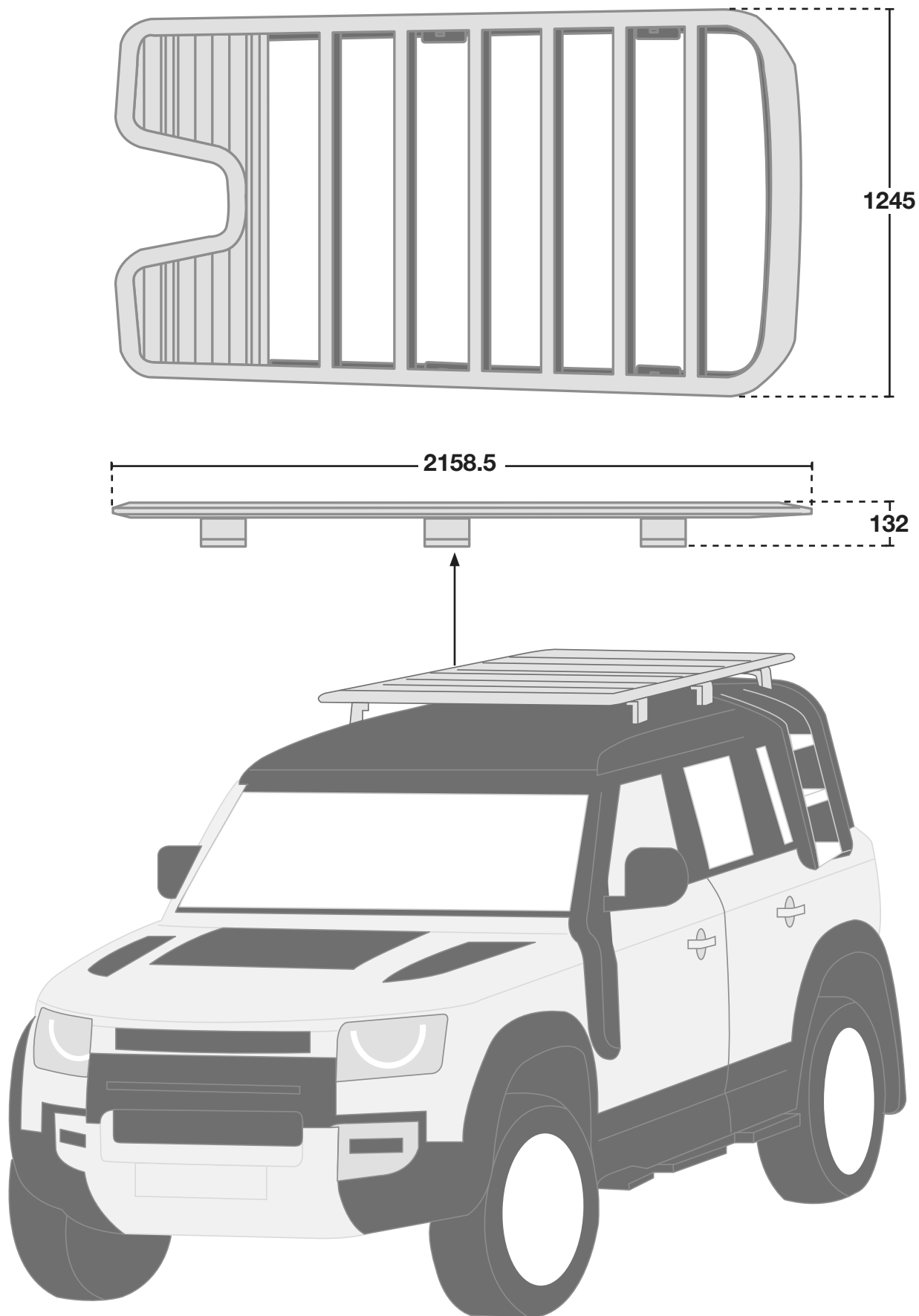

**Only available with Land Rover Defender 110, fitted to Expedition Roof Rack, Part No. VPLER0181.**

*Nur mit Land Rover Defender 110 erhältlich. Montiert auf esprdition Dachgepäckträger, Code: VPLER0181*

*Disponible seulement avec Land Rover Defender 110, monté dans le porte-bagages expedition, cod. VPLER0181*

*Disponibile solo con Land Rover Defender 110, montata sul portapacchi Expedition, codice VPLER0181.*

# WARNINGS

Avvertenze • Avertissement • Warnungen



MODELS <i>Modelle Modèles Modelli</i>	TENT WEIGHT <i>Zeltgewicht Poids de la tente Peso della tenda</i>	MAXIMUM OCCUPANTS WEIGHT <i>Maximales Bewohnergewicht Poids Maximum des occupants Peso massimo degli occupanti</i>	MEASURES WHEN CLOSE <i>Abmessungen bei geschlossenem Zelt Dimensions (tente fermée) Misure chiuse</i>	MEASURES WHEN OPEN <i>Abmessungen bei offenem Zelt Dimensions (tente ouverte) Misure aperte</i>	INTERNAL VOLUME* <i>Innenvolumen Capacité interne de la tente Capacità interna</i>
Land Rover Small X-Long	ca. 64 kg	 ca. 180 kg	130x230x33 cm	130x230x150 cm	ca. 210 l

The GRP (fiberglass) outer shells are all handmade and finished, therefore some variations may appear in the finished weights (Manufacturers tolerance rate is within 10%).

Da die Herstellung der Glasfaserschalen manuell erfolgt, können unterschiedliche Zeltgewichte auftreten.

(Da es sich bei Dachzelten um handwerklich gefertigte Produkte handelt, sind Abweichungen bei Gewichten und Abmessungen im Rahmen üblicher Toleranz (10% möglich).

La production des coques en fibre résine est réalisée à la main, raison pour laquelle il est possible de noter des différences de poids au niveau de la tente (la marge de tolérance de fabrication est de l'ordre de 10%).

La produzione dei gusci in vetroresina è realizzata manualmente, di conseguenza è possibile riscontrare delle variazioni del peso della tenda (la tolleranza nell'ambito della costruzione di fabbrica è del 10%).

(\*) Approximate value indicating the volumetric capacity of the upper shell of the tent, when the tent is closed

Ungefähres Volumen des Stauraums in der oberen Zeltschale, bei geschlossenem Zustand.

Valeur approximative indiquant la capacité volumétrique de la coque supérieure lorsque la tente est fermée

Valore approssimativo che indica, a tenda chiusa, la capacità volumetrica del guscio superiore.

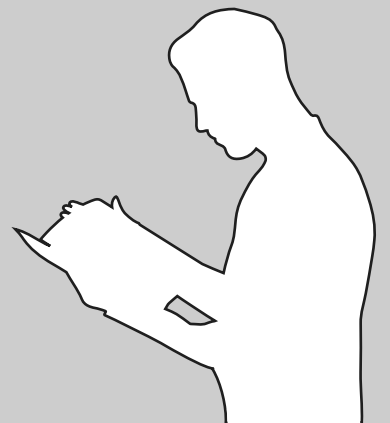
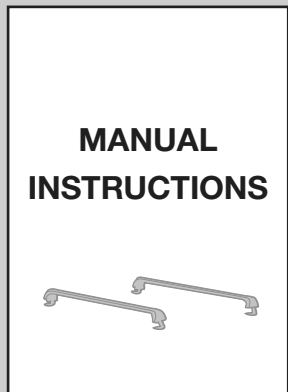
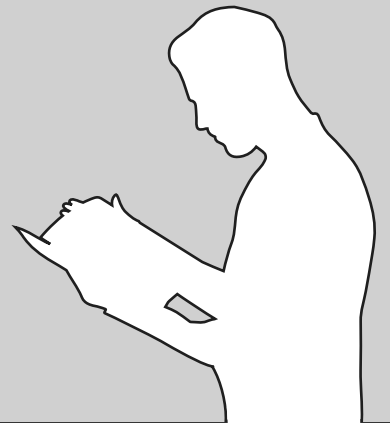
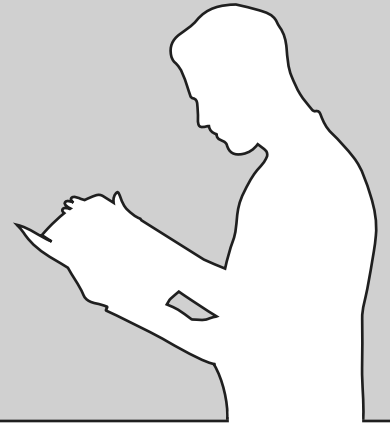
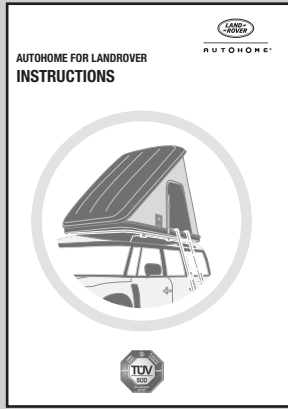

**Kg P1**

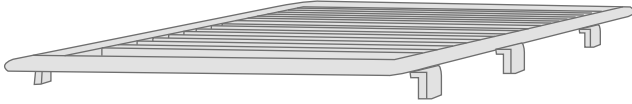

**Kg P2**



**(P1 + P2) ≤ Kg P<sub>MAX</sub>**



**Kg P<sub>MAX</sub>**

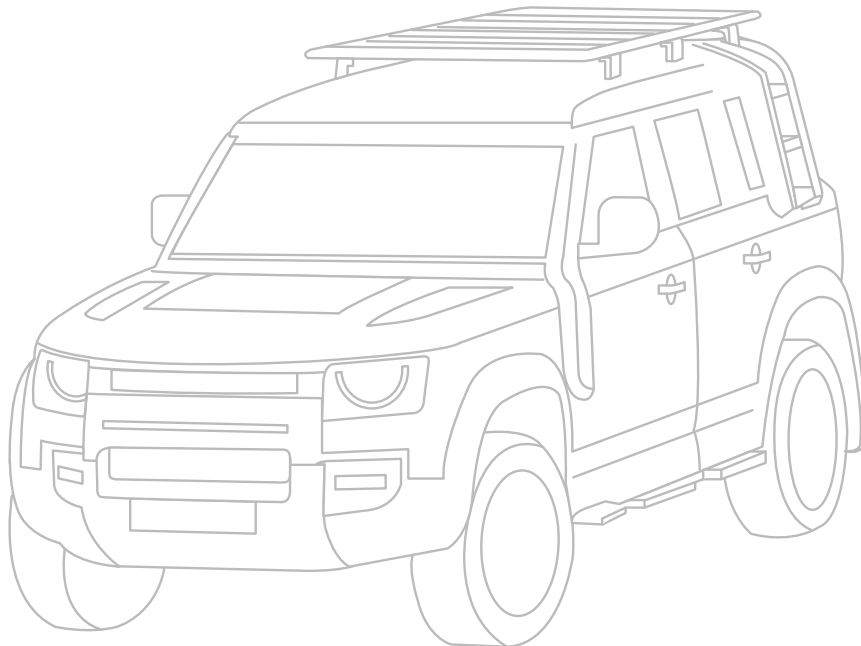

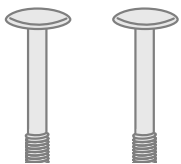
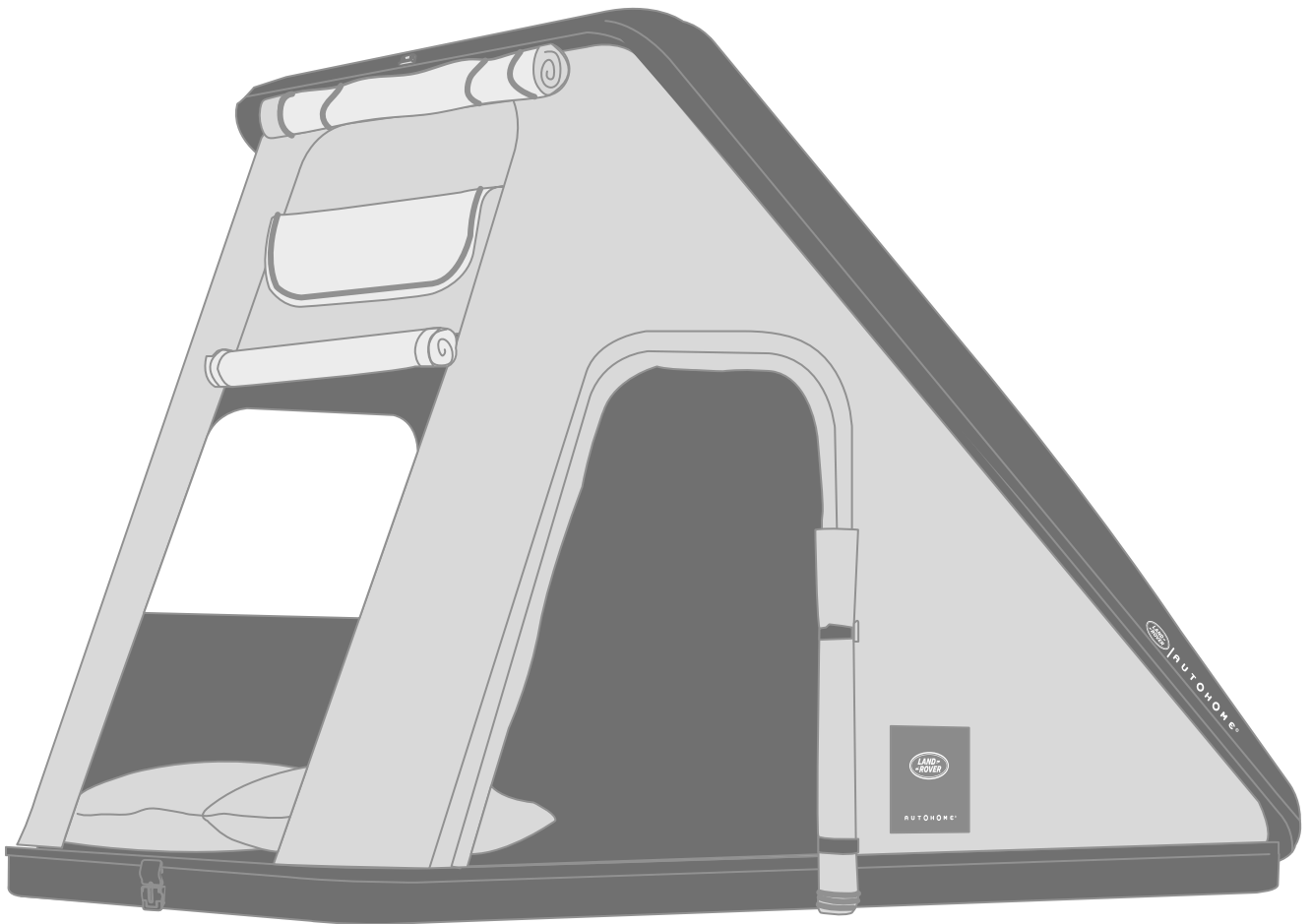

**X8**

**UP**



**X4**

**UNDER**

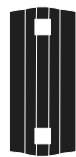

**X4**



**X8**

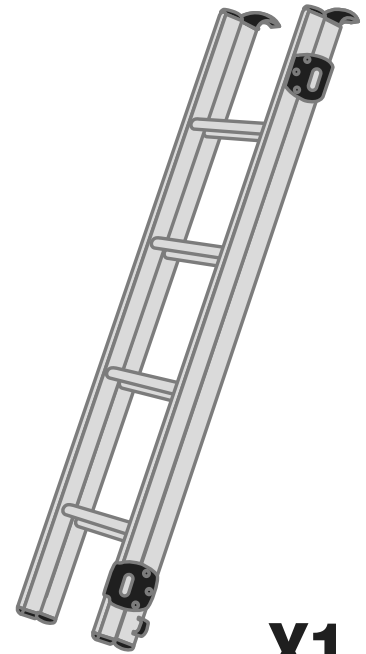

**X1**

# POSITIONING

*Posizionamento • Placement • Platzierung*

1

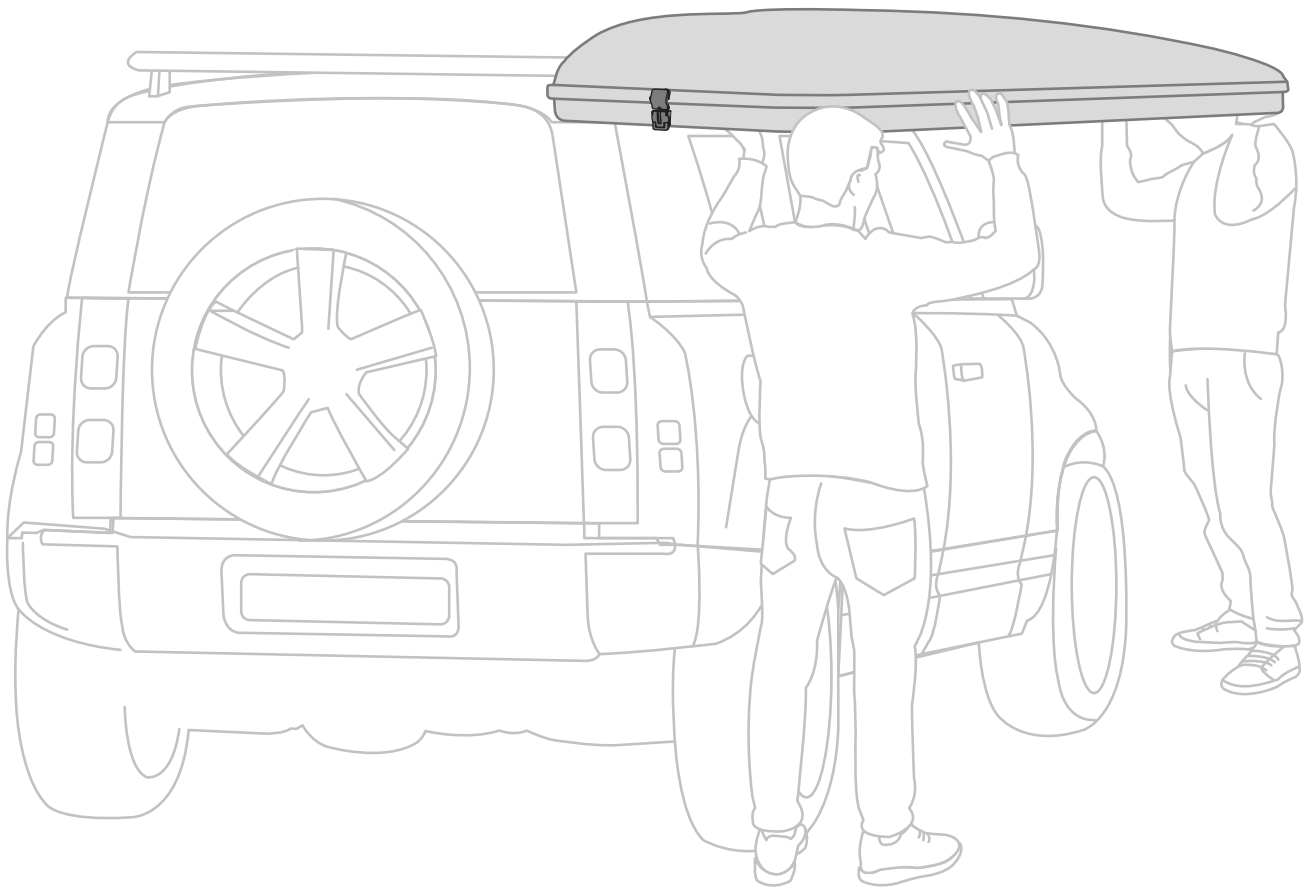
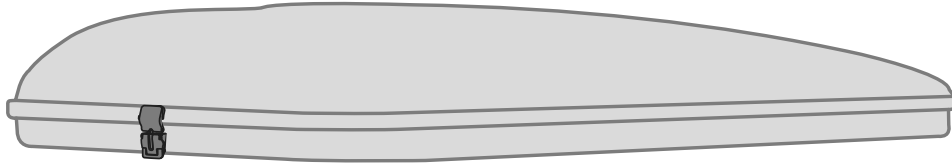



2

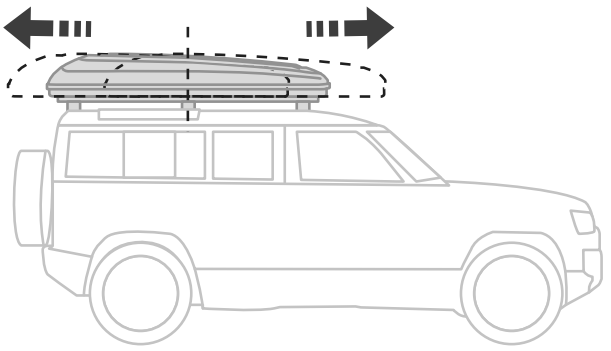
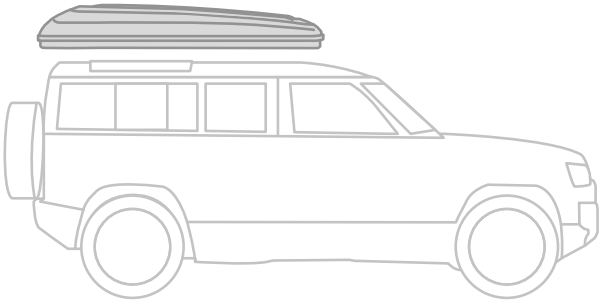
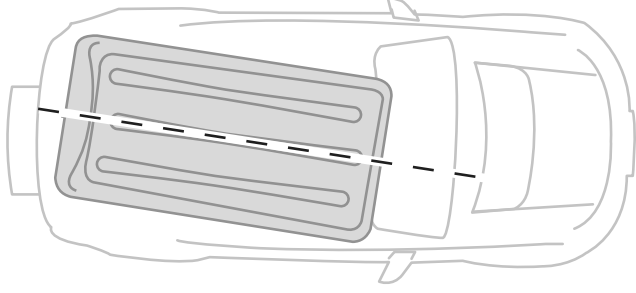
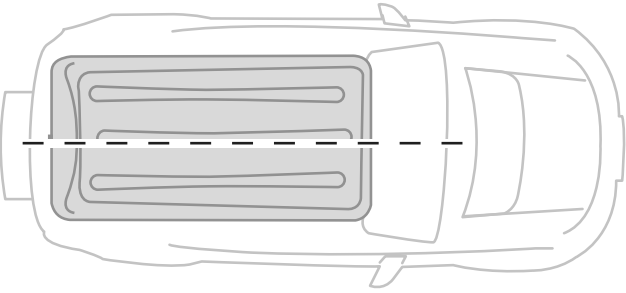
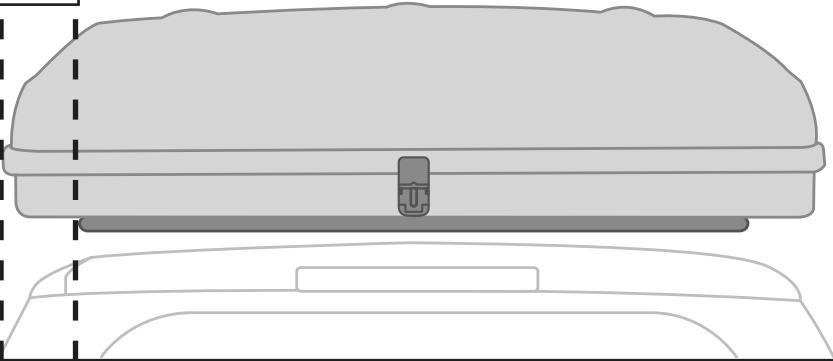

# FIXING

Fissaggio • Fixation • Befestigung

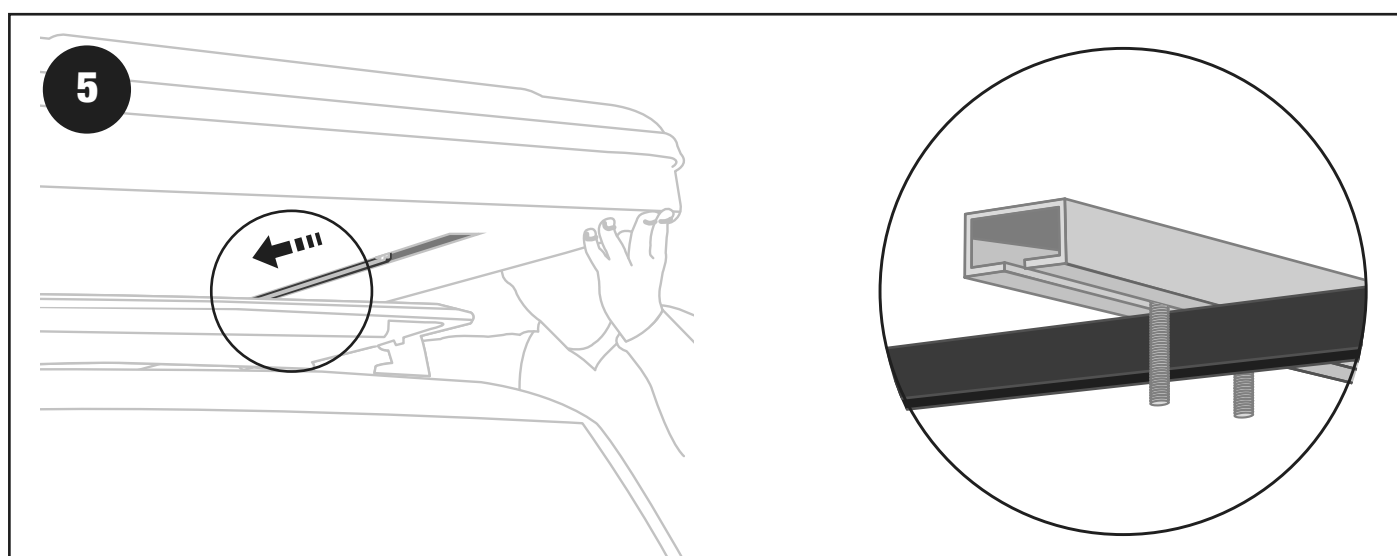
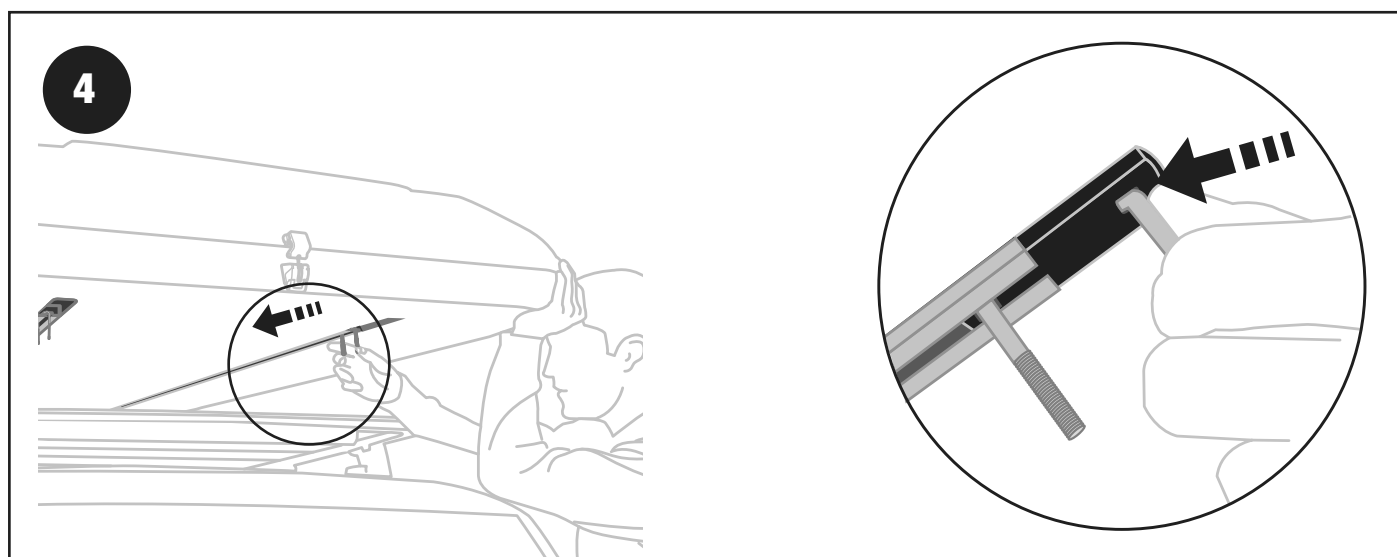
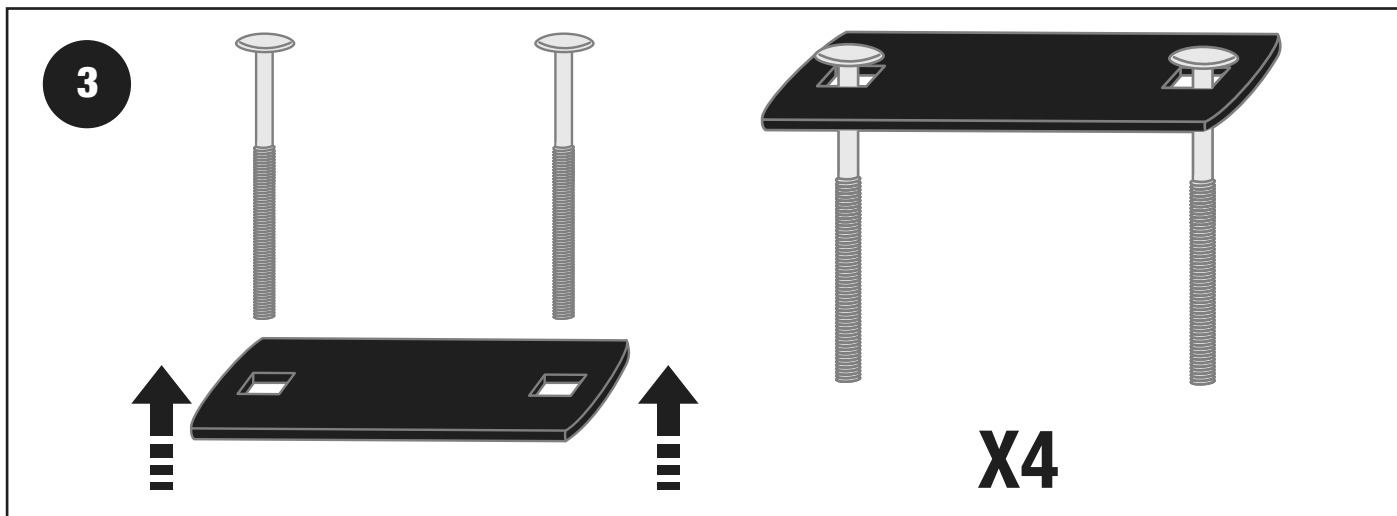

**6**

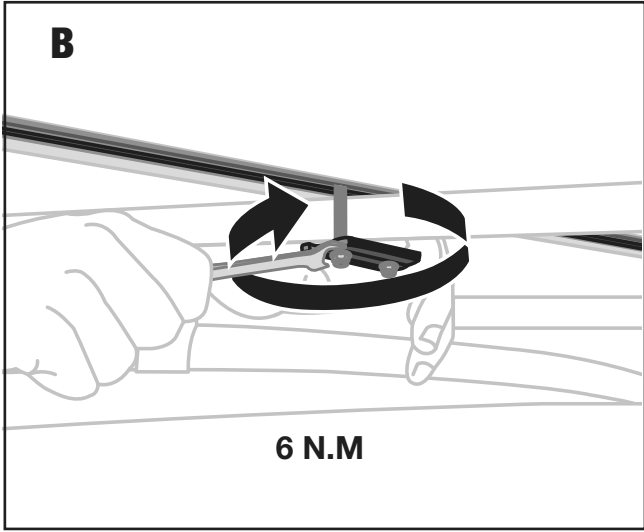
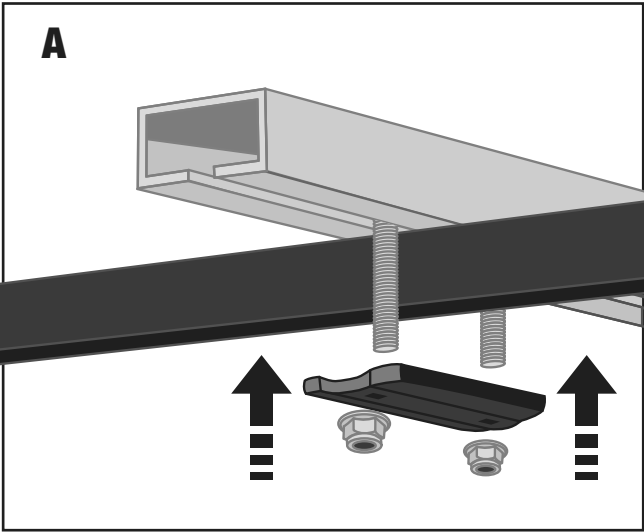

**7**

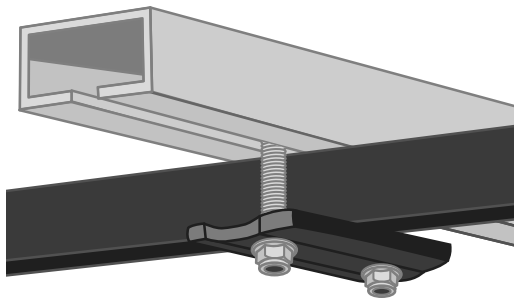
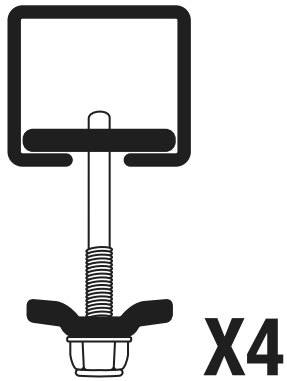
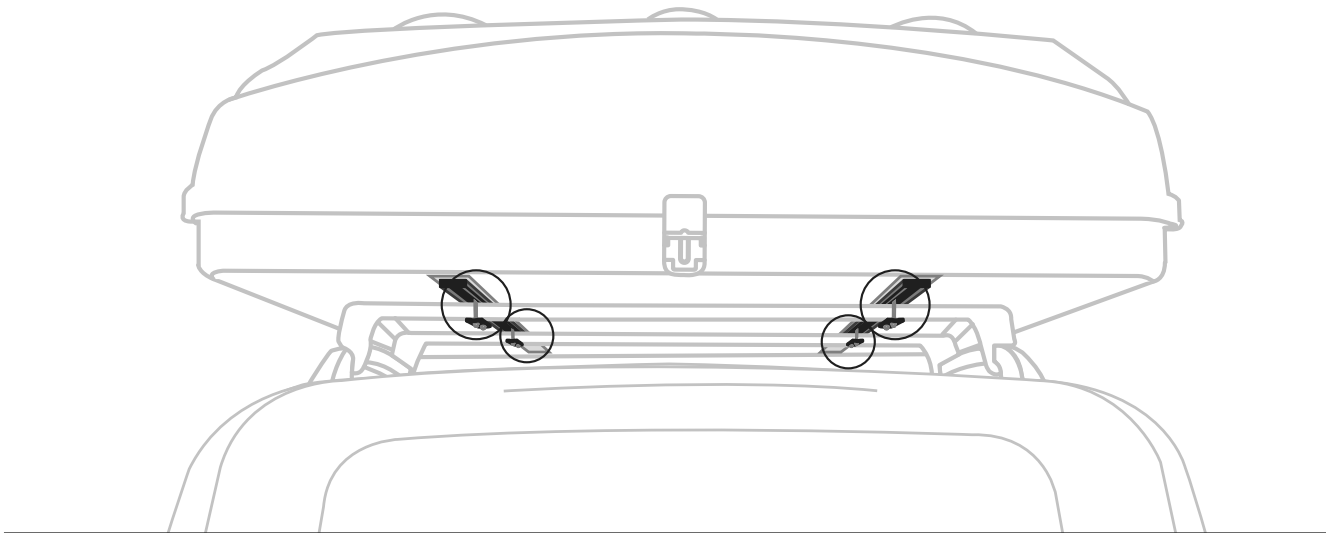

# OPENING

Apertura • Overture • Öffnung

8

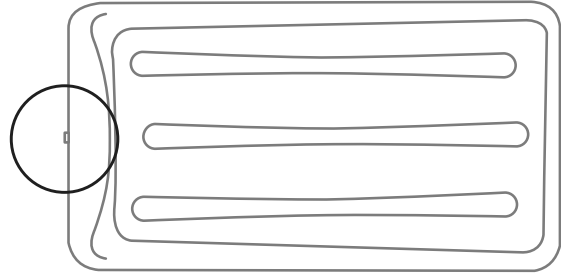
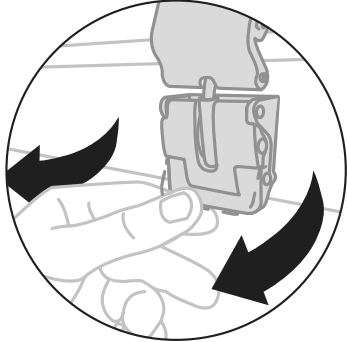

A

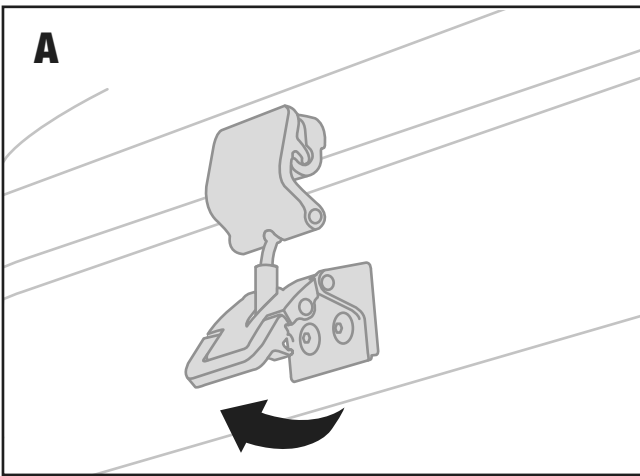

B

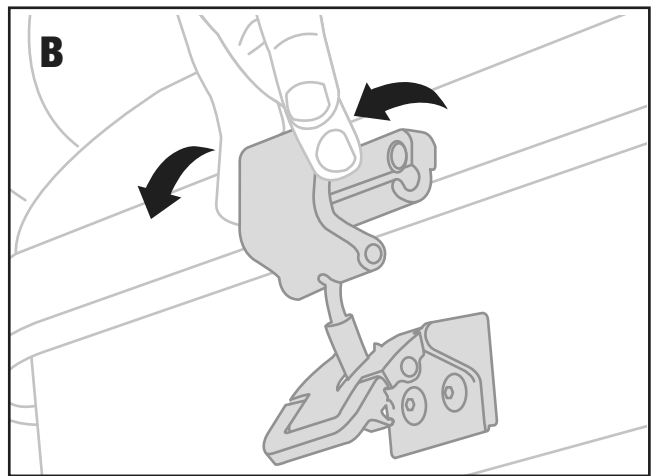

9

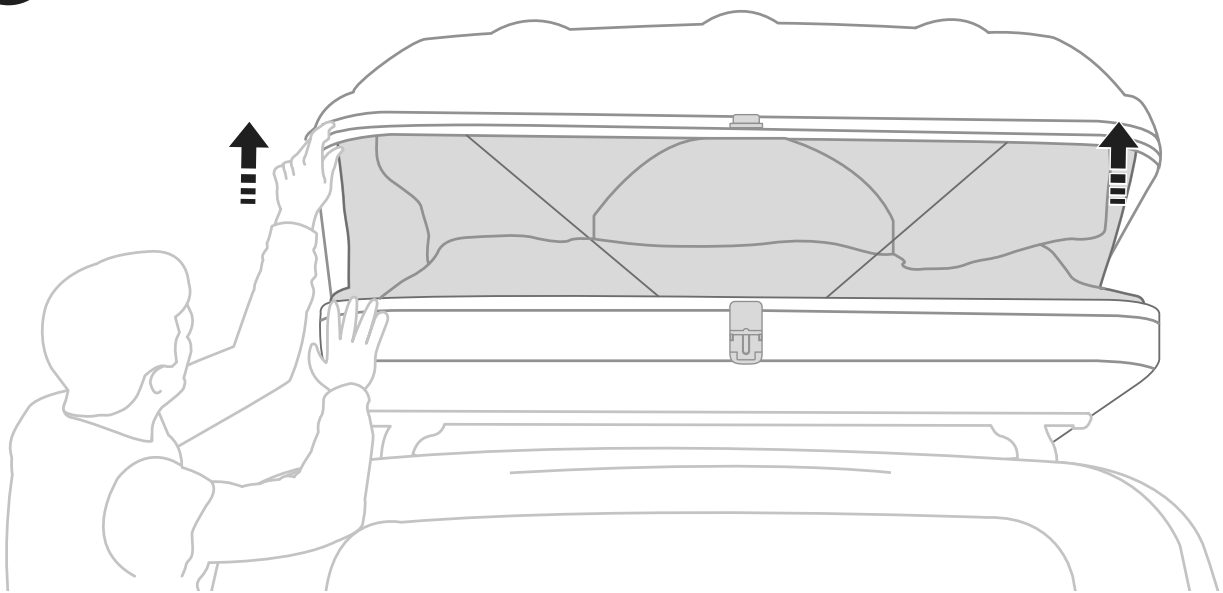

10

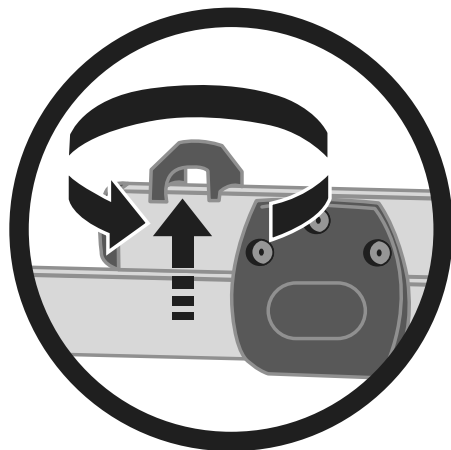
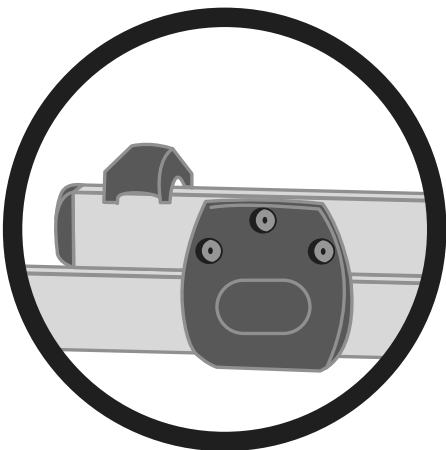
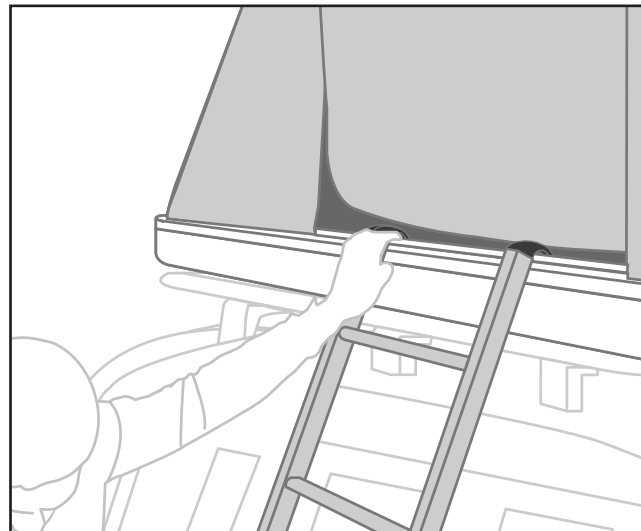
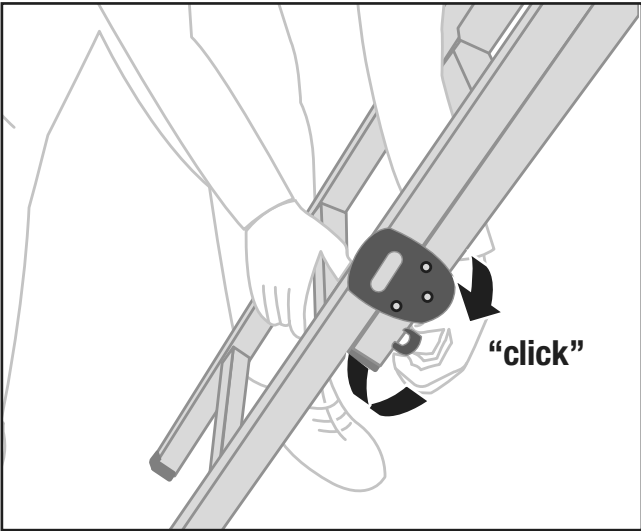
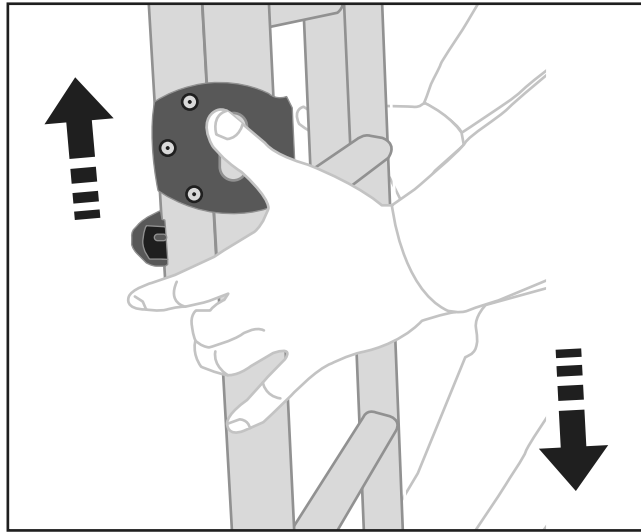
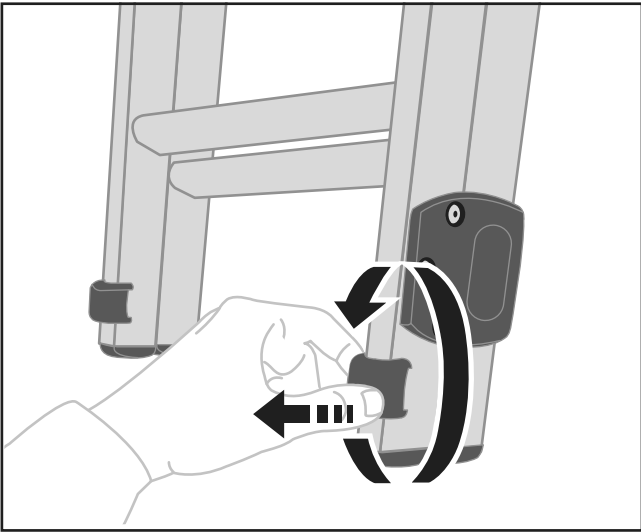

11

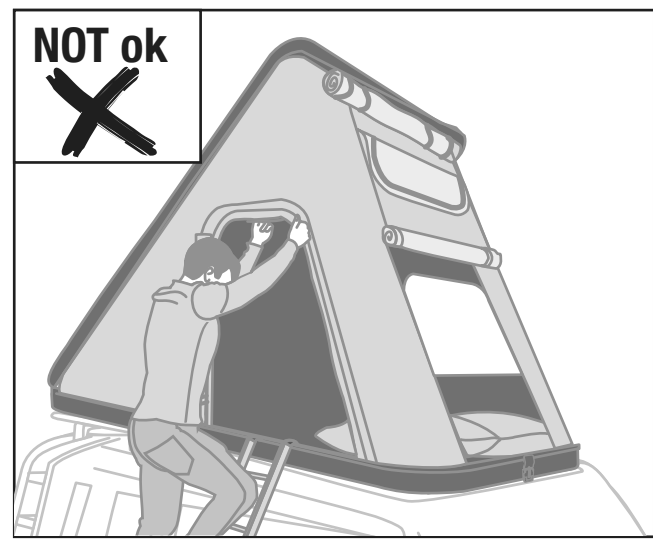
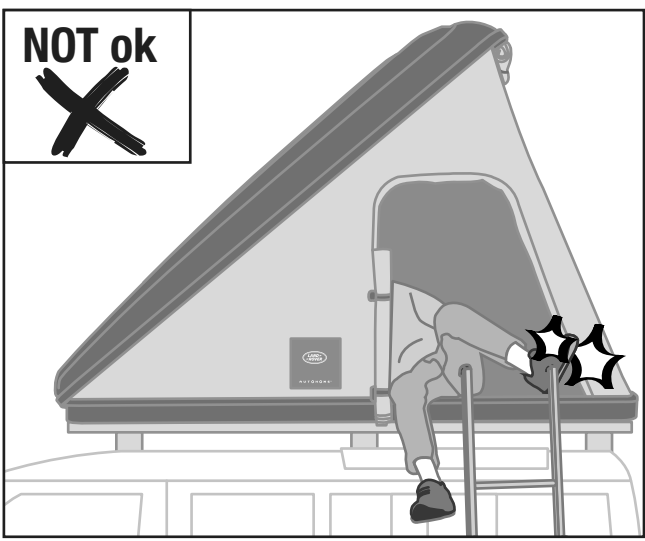
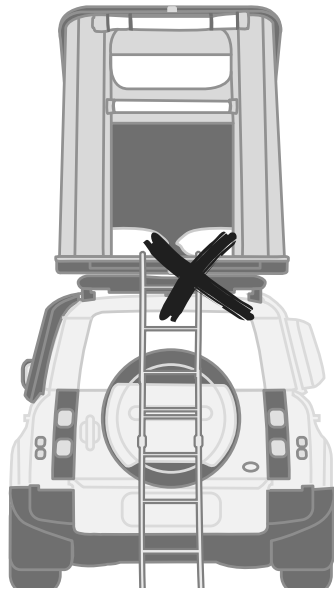
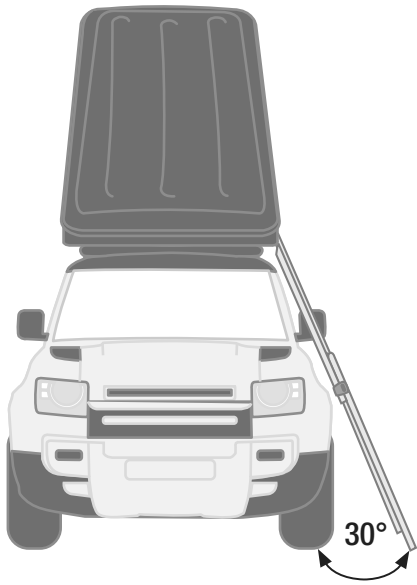
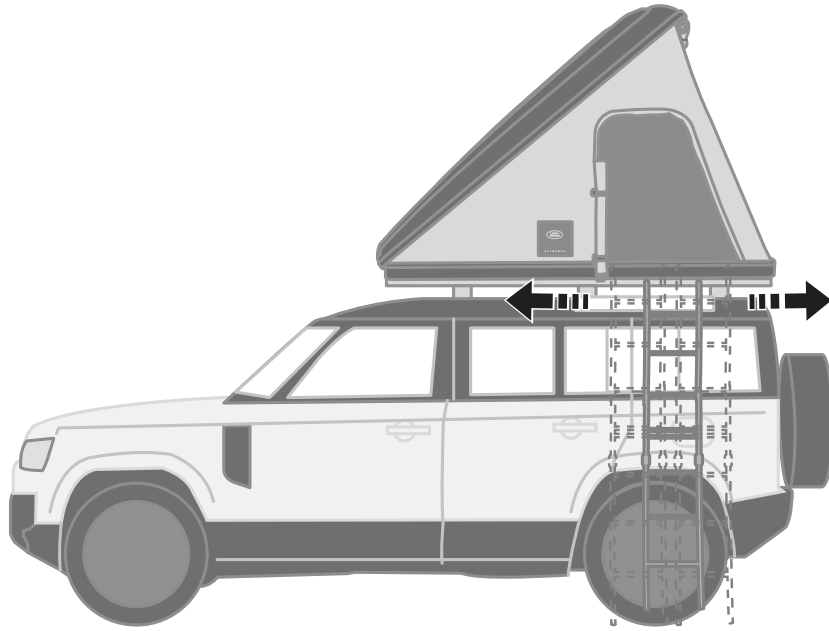

# Land Rover ladder

*Scala Land Rover • Échelle Land Rover • Land Rover leiter*

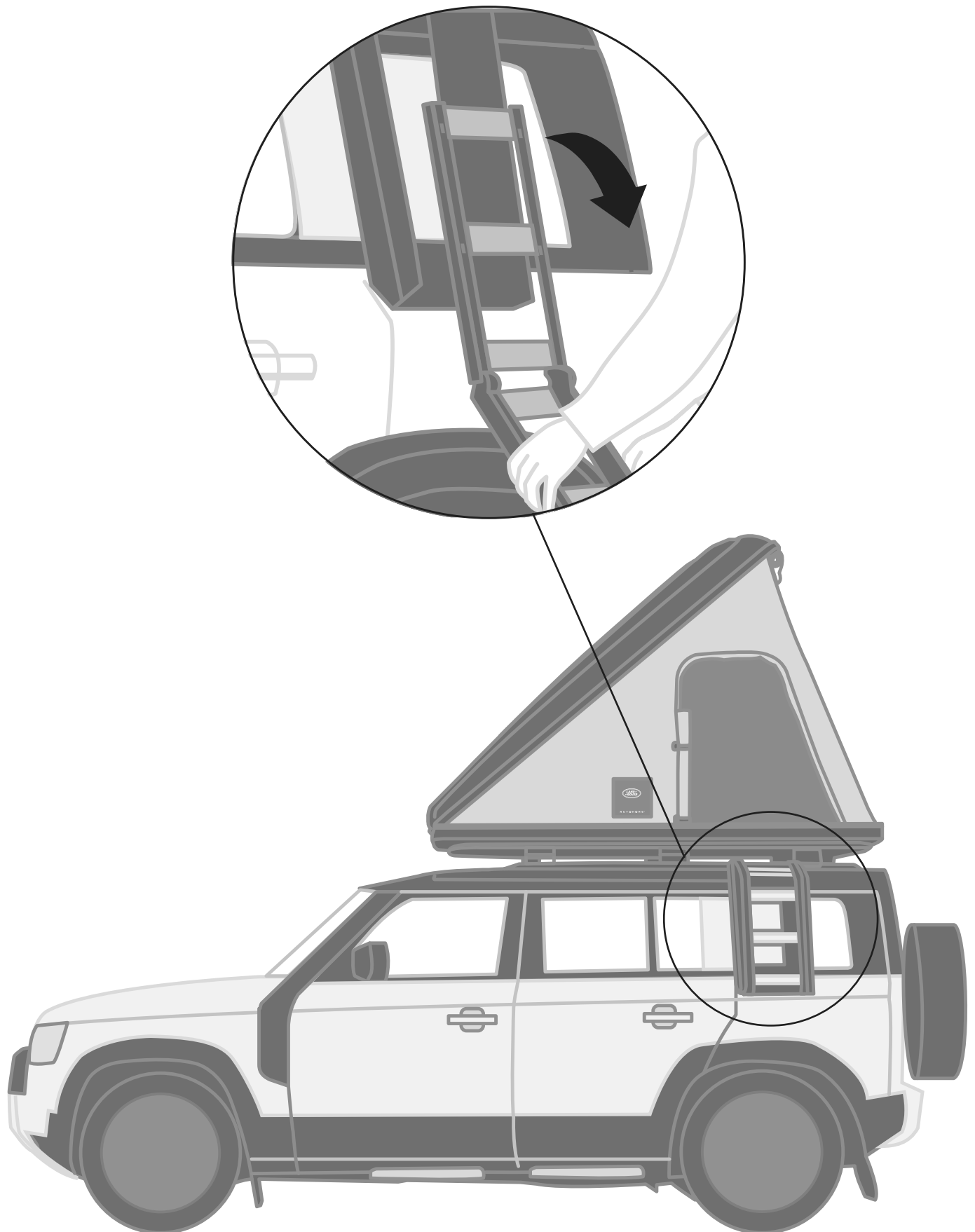

12

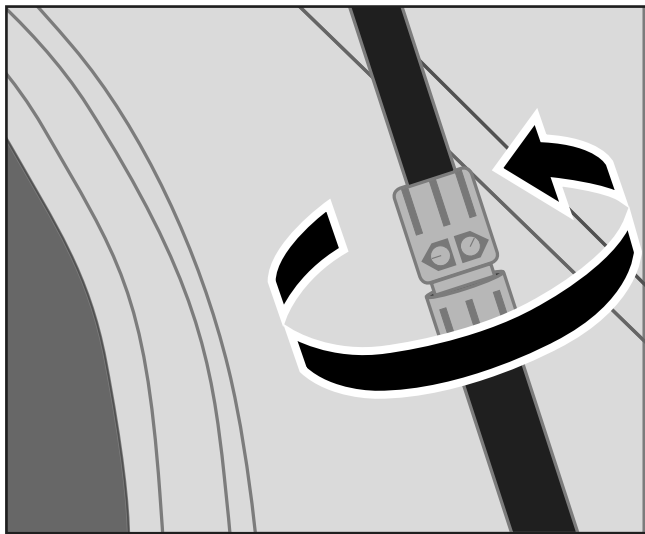



# CLOSING

Chiusura • Fermeture • Schließung

13

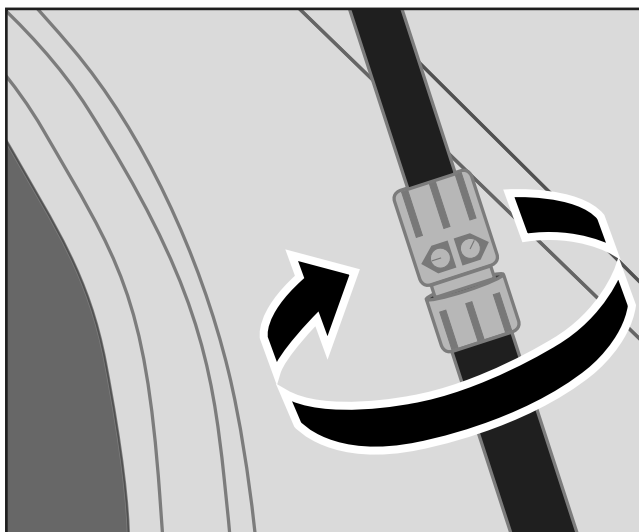

14

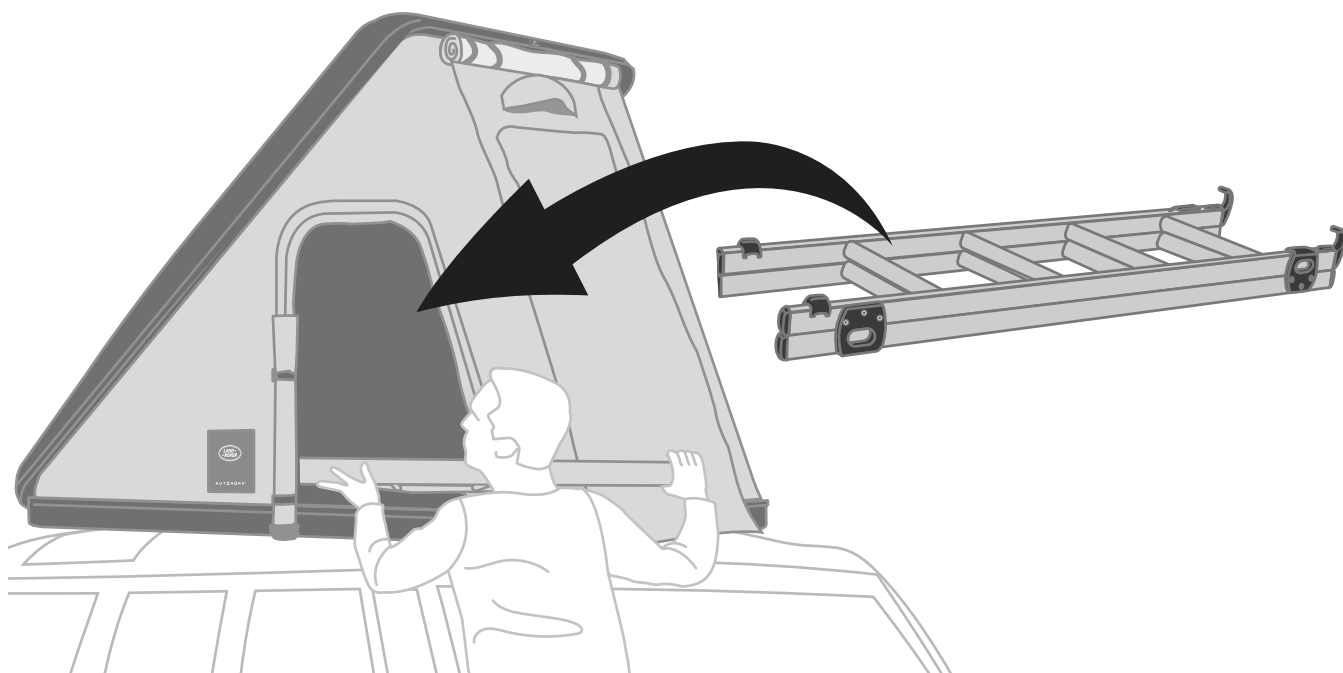

ok ✓

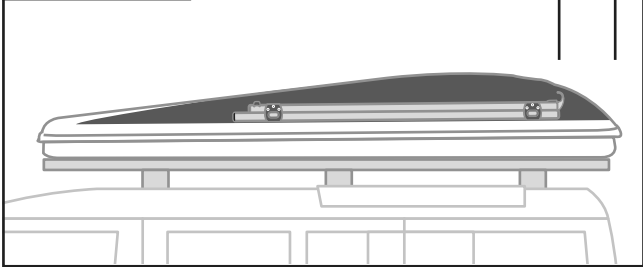

NOT ok ✗

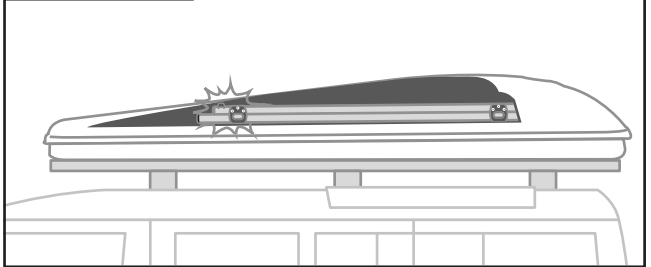

15

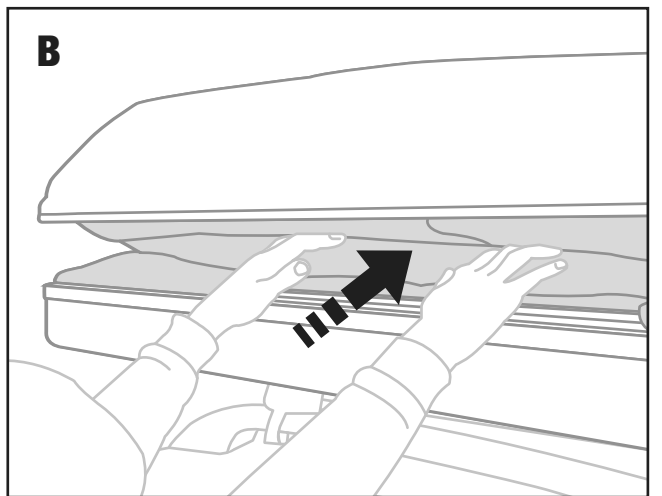
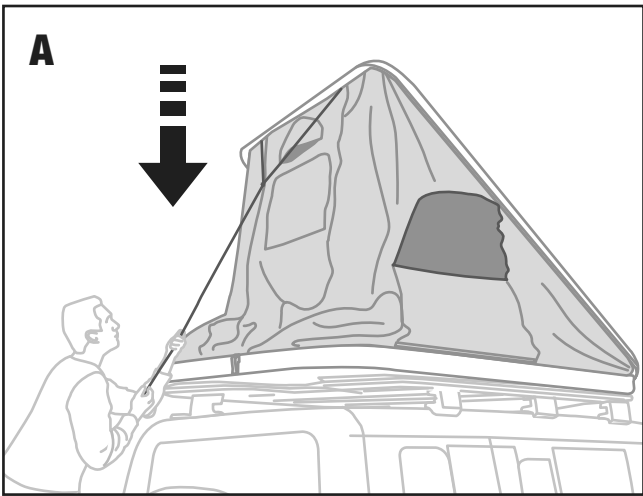

ok ✓

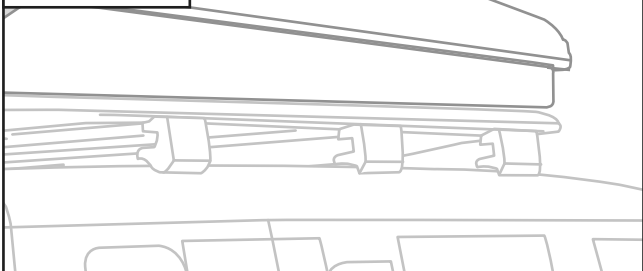

NOT ok ✗

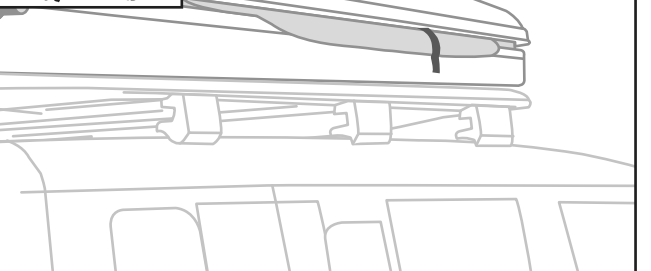

17

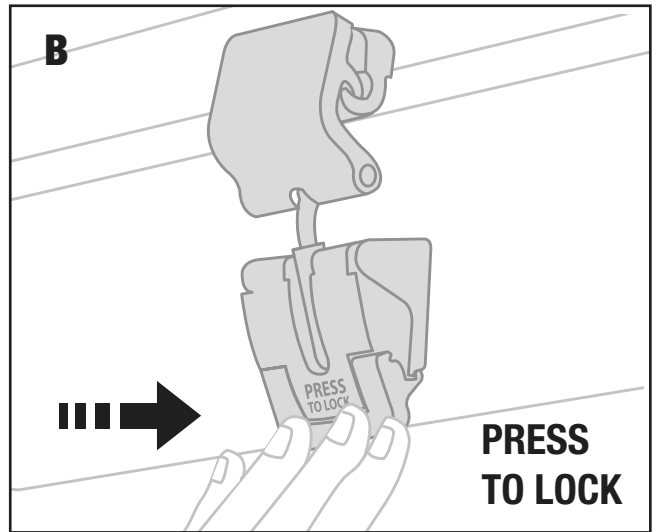
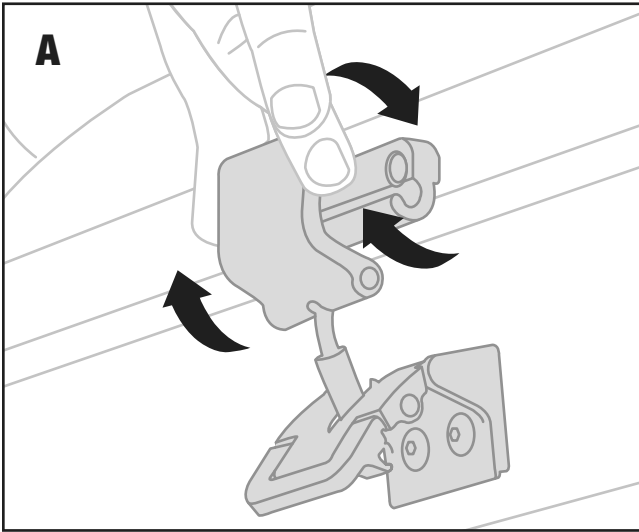
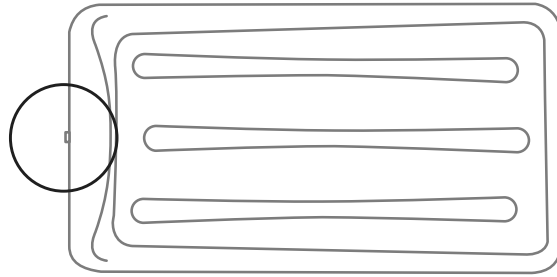

18

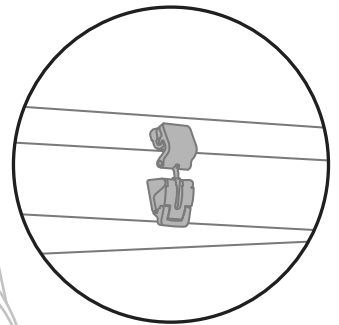
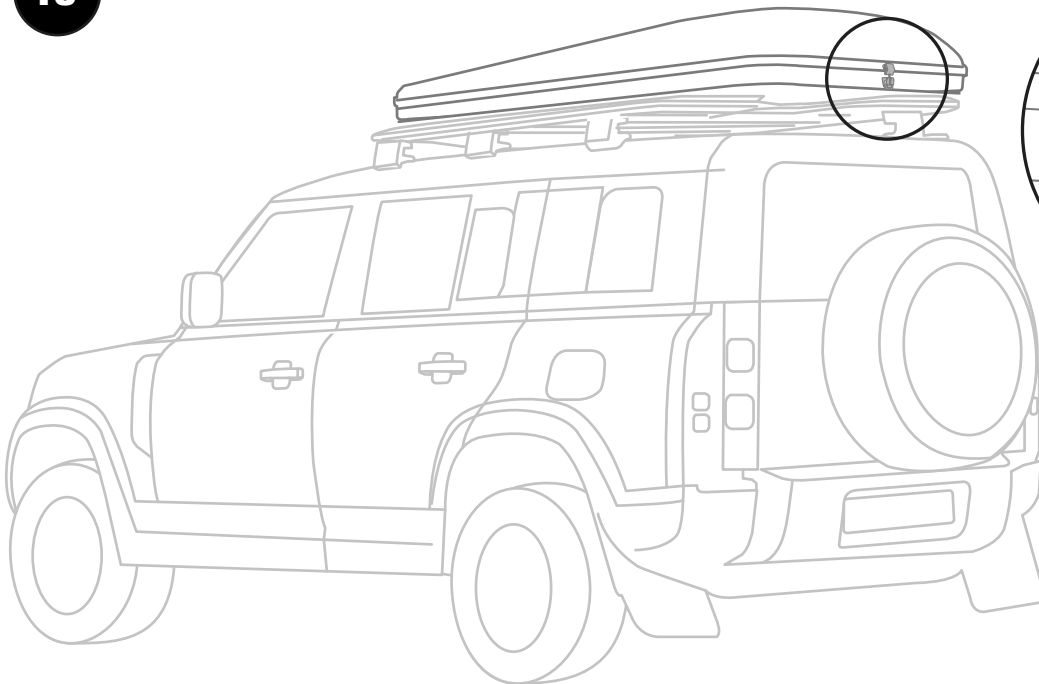

# SUNSHADE

Tendalino • Bâche • Sonnensegel

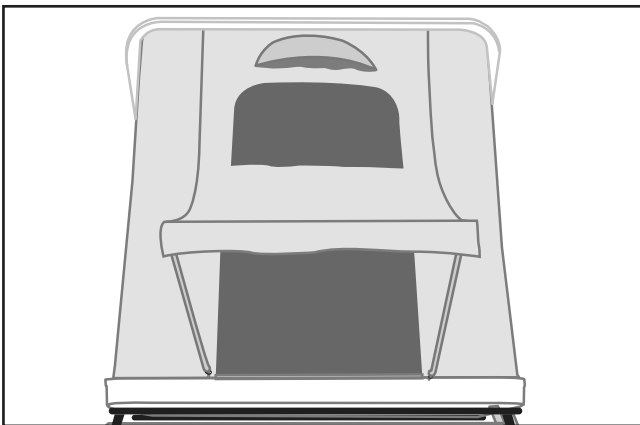
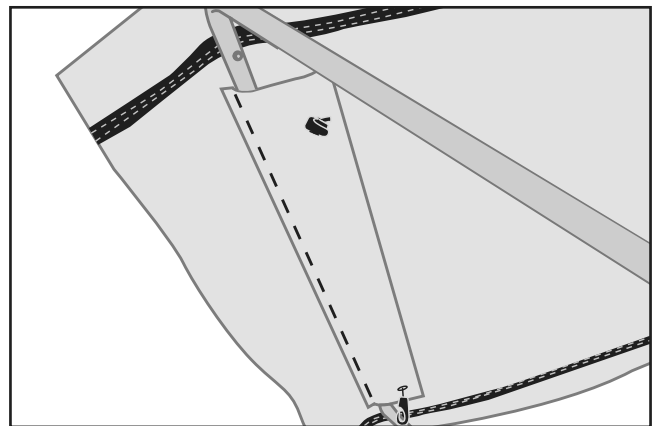
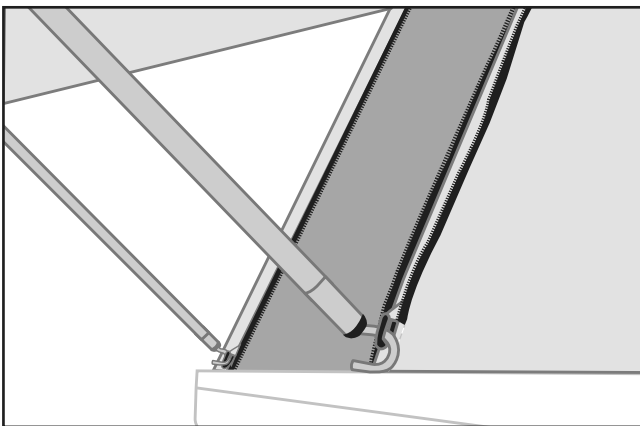

# LAMP

Lampada • Lampe • Lampe

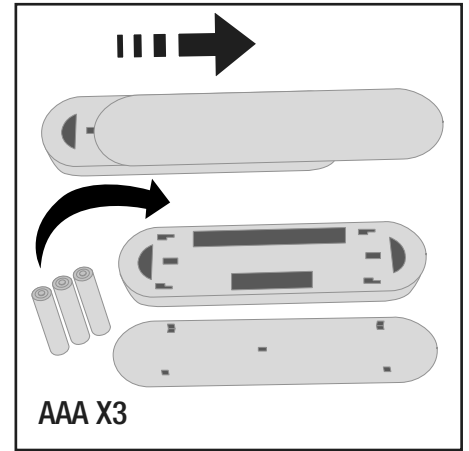
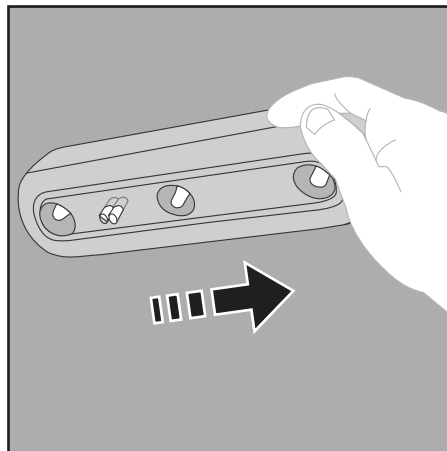
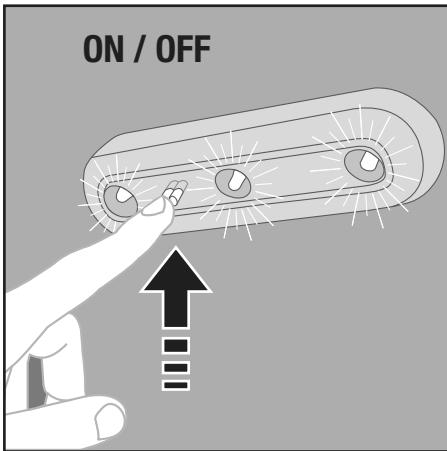

# HANDLE WITH CARE

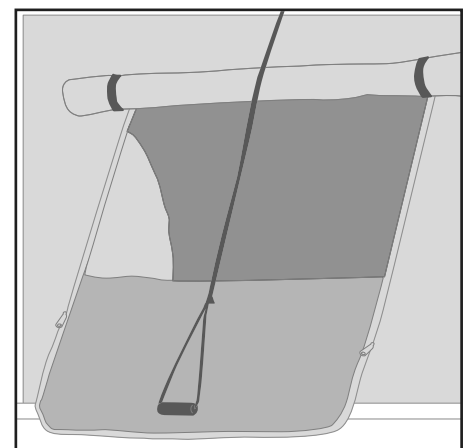
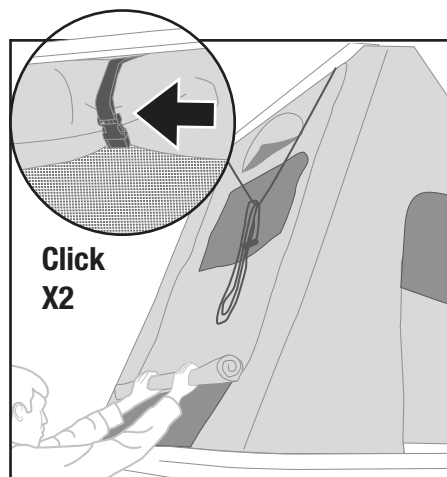
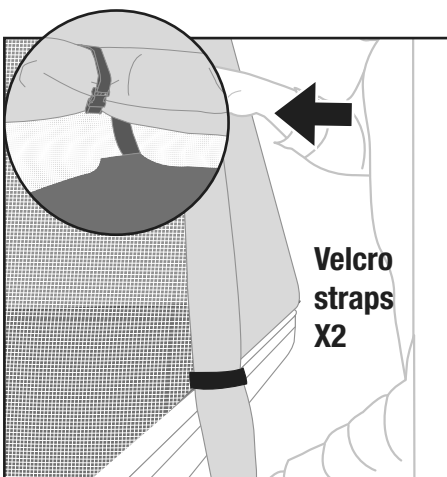
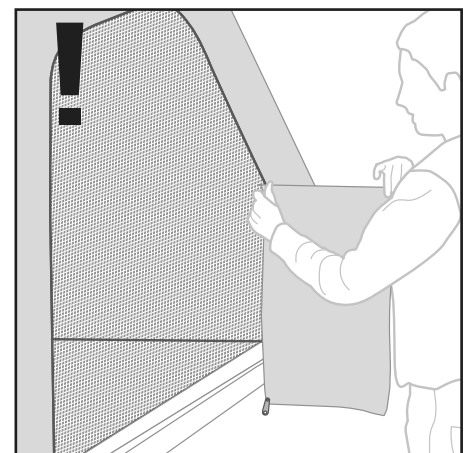
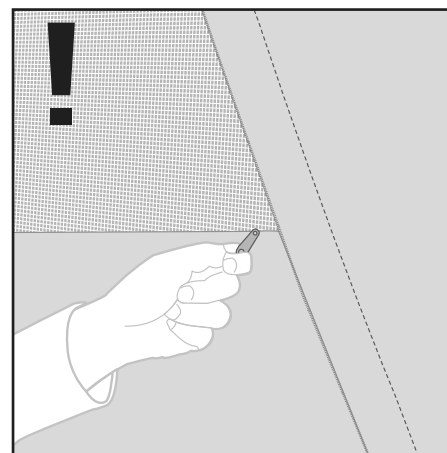
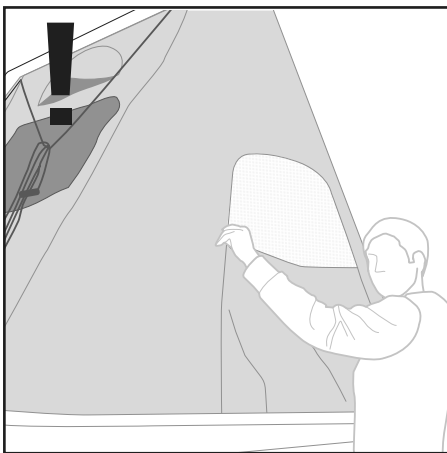

# WARNINGS

Avvertenze • Avertissement • Warnungen

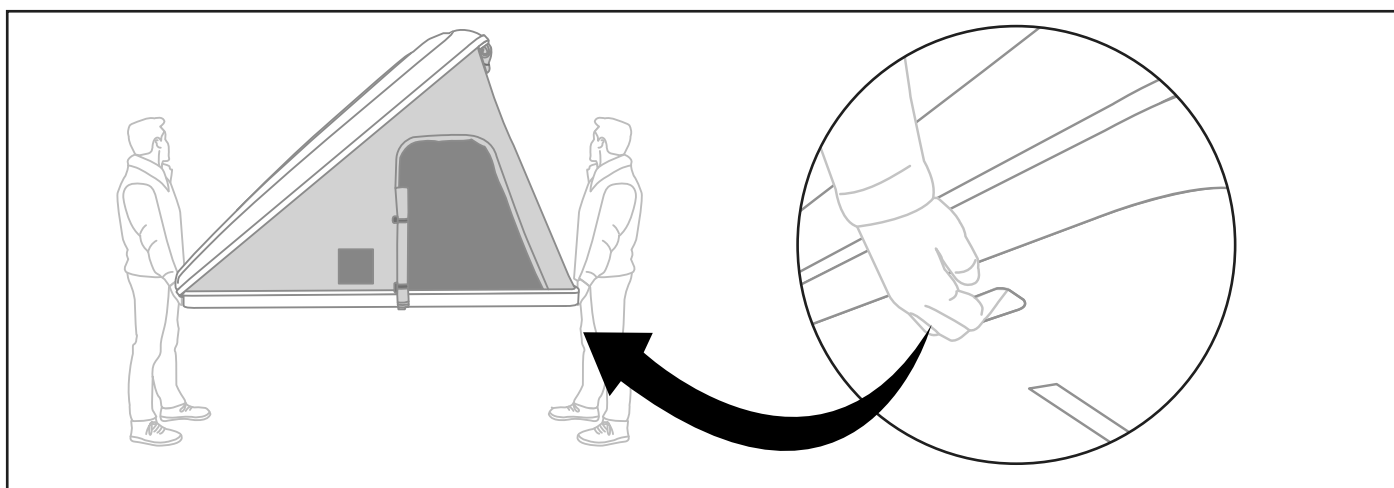
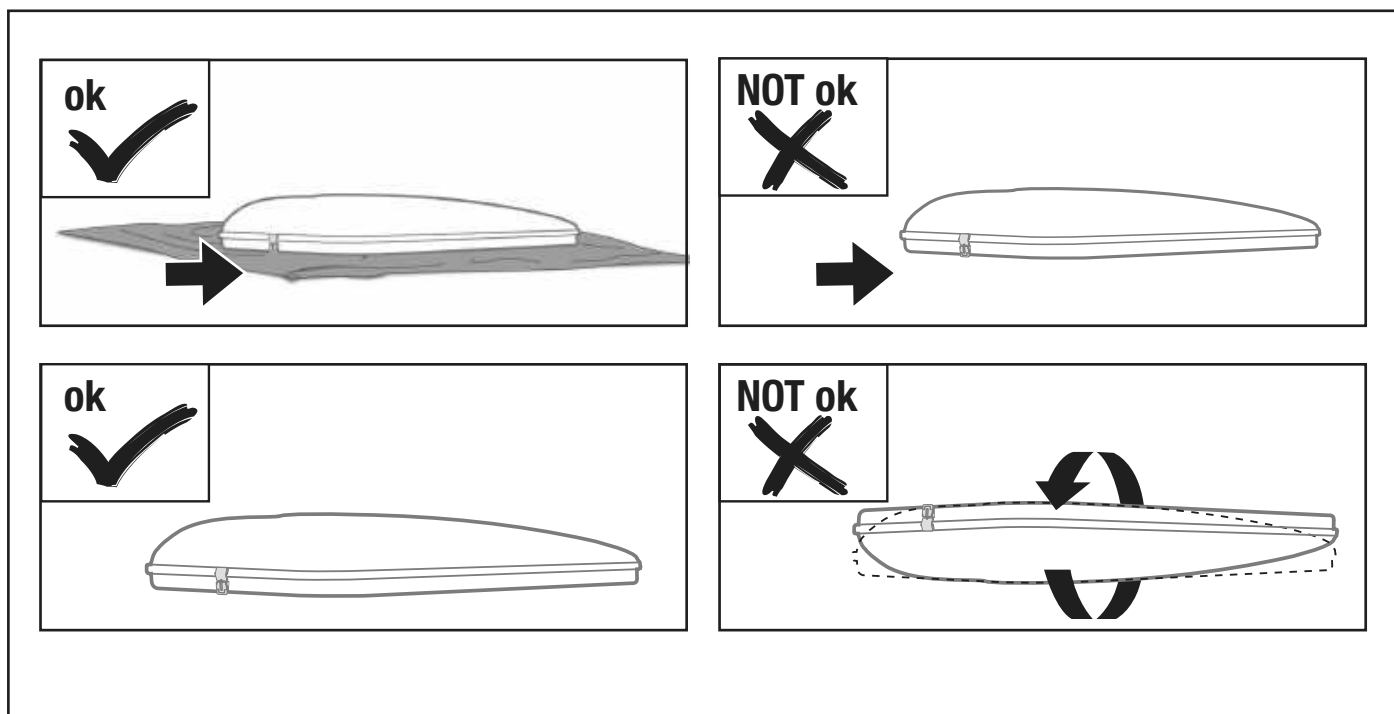
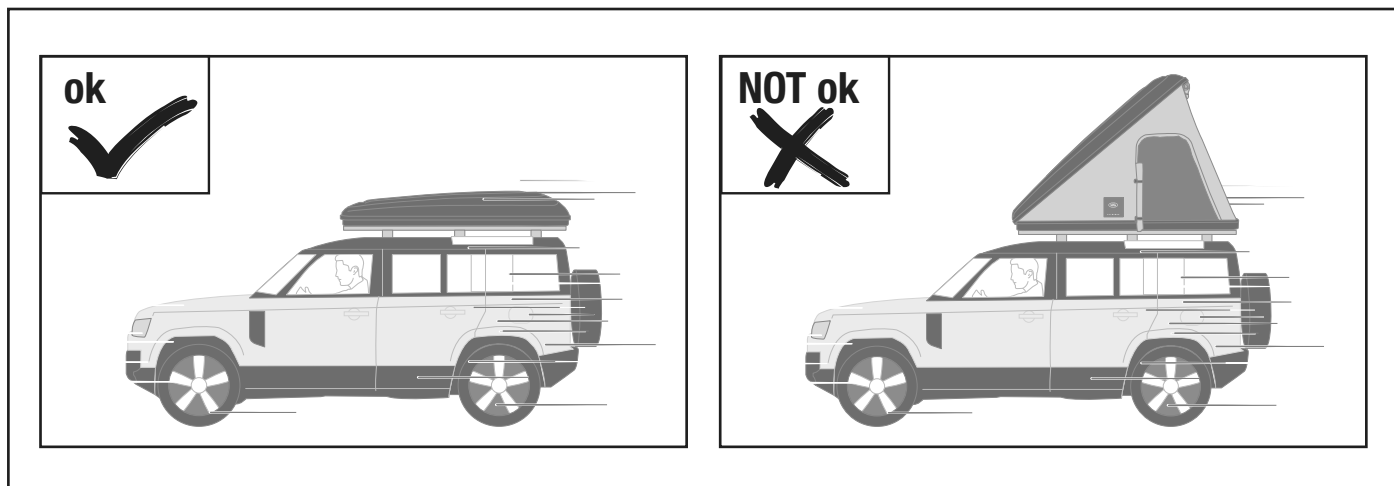

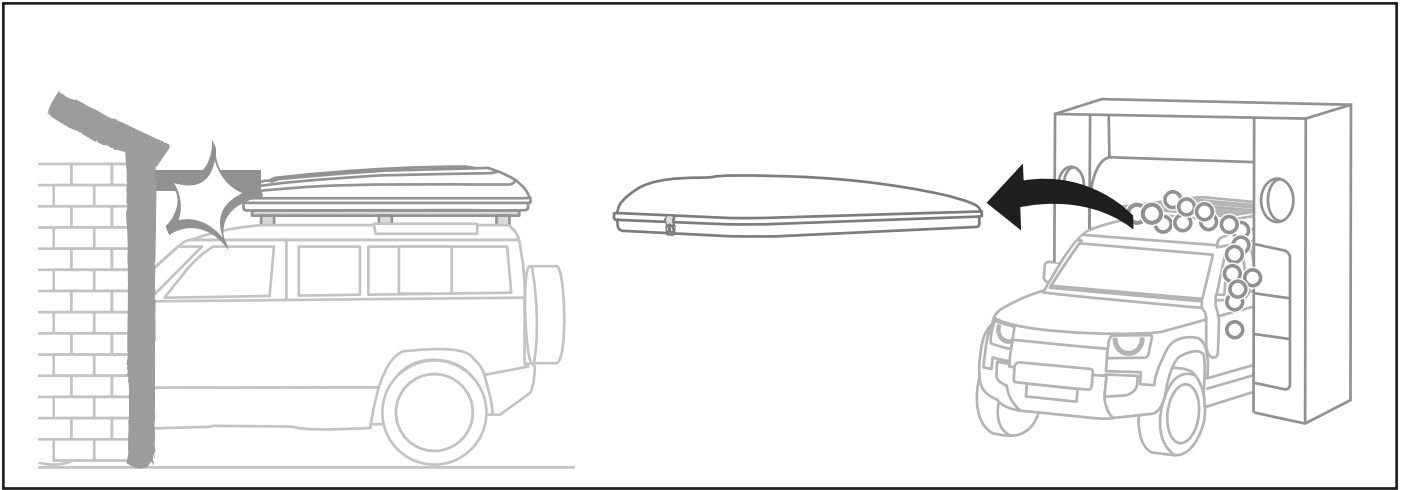





**AUTOHOME®** produced by  
Zifer Italia Srl  
Viale Risorgimento, 23  
46017 Rivarolo Mantovano  
(Mantova) Italy  
Tel. +39 0376 99590  
+39 0376 958164  
Fax +39 0376 958088

**AUTOHOME-OFFICIAL.COM**  
info@autohome.it

 MADE IN ITALY

 Autohome Official-Page

 autohome\_official



PRODUCT QUALITY CERTIFICATION